

PLANNING COMMISSION AGENDA

CHAIRPERSON:

Brett Taylor



VICE CHAIRPERSON:

Liz Wynn

COMMISSIONERS: Brett Taylor, Liz Wynn, Chris Gomez, Marvin Hansen, Sarrah Peariso

MONDAY, AUGUST 14, 2017, 7:00 PM REGULAR MEETING, COUNCIL CHAMBERS, 707 W. ACEQUIA, VISALIA CA

1. THE PLEDGE OF ALLEGIANCE –
2. CITIZEN'S COMMENTS – This is the time for citizens to comment on subject matters that are not on the agenda but are within the jurisdiction of the Visalia Planning Commission. The Commission requests that a 5-minute time limit be observed for comments. Please begin your comments by stating and spelling your name and providing your street name and city. Please note that issues raised under Citizen's Comments are informational only and the Commission will not take action at this time.
3. CHANGES OR COMMENTS TO THE AGENDA–
4. CONSENT CALENDAR - All items under the consent calendar are to be considered routine and will be enacted by one motion. For any discussion of an item on the consent calendar, it will be removed at the request of the Commission and made a part of the regular agenda.
 - No Items on Consent Calendar
5. PUBLIC HEARING – Paul Scheibel
Variance No. 2017-14: A request by California Water Service Company to allow a variance to the maximum height limit in the rear yard of an R-1-5 (Single-family Residential) zoned property, for the installation of two water treatment tanks. The site is located at 901 South Tipton St. (APN: 097-105-003) The project is Categorically Exempt from the California Environmental Quality Act (CEQA) pursuant to CEQA Guidelines Section 15305, Categorical Exemption No. 2017-64.
6. PUBLIC HEARING – Andy Chamberlain
Variance No. 2017-15: A request by California Water Service Company to allow a variance to the maximum height limit in the rear yard of an R-1-5 (Single-family Residential) zoned property, for the installation of two water holding tanks. The site is located at 1920 W. Ashland Avenue. (APN: 122-021-002) The project is Categorically Exempt from the California Environmental Quality Act (CEQA) pursuant to CEQA Guidelines Section 15305, Categorical Exemption No. 2017-57.
7. PUBLIC HEARING – Andy Chamberlain
Variance No. 2017-16: A request by California Water Service Company to allow a variance to the maximum height limit in the rear yard of an R-1-5 (Single-family Residential) zoned property, for the installation of three water treatment tanks. The site is located at 1622 S. Demaree Street. (APN: 095-232-009) The project is Categorically Exempt from the California Environmental Quality Act (CEQA) pursuant to CEQA Guidelines Section 15305, Categorical Exemption No. 2017-58.

8. PUBLIC HEARING – Brandon Smith

- a. Conditional Use Permit No. 2017-25: A request by Salim Development c/o Tahir Salim to allow a planned commercial development consisting of a parcel without access rights onto a public street on land in the Commercial Mixed Use (CMU) Zone. The project site is located on the north side of Noble Avenue between Ben Maddox Way and the State Route 198 eastbound off-ramp. (APN: 100-030-022) The project is Categorically Exempt from the California Environmental Quality Act (CEQA) pursuant to CEQA Guidelines Section 15315, Categorical Exemption No. 2017-55.
- b. Tentative Parcel Map No. 2017-01: A request by Salim Development c/o Tahir Salim to subdivide a 1.02-acre parcel into two parcels to facilitate commercial development on land in the Commercial Mixed Use (CMU) Zone. The project site is located on the north side of Noble Avenue between Ben Maddox Way and the State Route 198 eastbound off-ramp. (APN: 100-030-022) The project is Categorically Exempt from the California Environmental Quality Act (CEQA) pursuant to CEQA Guidelines Section 15315, Categorical Exemption No. 2017-55.

9. PUBLIC HEARING – Paul Scheibel

Conditional Use Permit No. 2017-26: A request to for a mixed use development, adding nine residential units to an existing commercial building in the D-MU (Downtown Mixed Use) Zone District. The project is located at 115 N. Court Street (APN: 094-324-007) The project is Categorically Exempt from the California Environmental Quality Act (CEQA) pursuant to CEQA Guidelines Section 15301, Categorical Exemption No. 2017-67.

10. PUBLIC HEARING – Paul Bernal

Conditional Use Permit No. 2017-30: A request by the Rise Church, EBM Design Group - Agent, to install three 960 square foot portable classrooms to be used for Sunday school purposes. The Rise Church is zoned R-1-20 (Single-Family Residential) and is located at 5702 West Caldwell Avenue on the northeast corner of West Caldwell Avenue and South Peppertree Court (APN: 119-690-049). The project is Categorically Exempt from the California Environmental Quality Act (CEQA) pursuant to CEQA Guidelines Section 15303, Categorical Exemption No. 2017-63.

11. DIRECTOR'S REPORT/ PLANNING COMMISSION DISCUSSION-

The Planning Commission meeting may end no later than 11:00 P.M. Any unfinished business may be continued to a future date and time to be determined by the Commission at this meeting. The Planning Commission routinely visits the project sites listed on the agenda.

For the hearing impaired, if signing is desired, please call (559) 713-4359 twenty-four (24) hours in advance of the scheduled meeting time to request these services. For the visually impaired, if enlarged print or Braille copy is desired, please call (559) 713-4359 for this assistance in advance of the meeting and such services will be provided as soon as possible following the meeting.

Any written materials relating to an item on this agenda submitted to the Planning Commission after distribution of the agenda packet are available for public inspection in the City Office, 315 E. Acequia Visalia, CA 93291, during normal business hours.

APPEAL PROCEDURE

THE LAST DAY TO FILE AN APPEAL IS THURSDAY, AUGUST 24, 2017 BEFORE 5 PM

According to the City of Visalia Zoning Ordinance Section 17.02.145 and Subdivision Ordinance Section 16.04.040, an appeal to the City Council may be submitted within ten days following the date of a decision by the Planning Commission. An appeal form with applicable fees shall be filed with the City Clerk at 220 N. Santa Fe, Visalia, CA 93292. The appeal shall specify errors or abuses of discretion by the Planning Commission, or decisions not supported by the evidence in the record. The appeal form can be found on the city's website www.visalia.city or from the City Clerk.

THE NEXT REGULAR MEETING WILL BE HELD ON MONDAY, AUGUST 28, 2017



REPORT TO CITY OF VISALIA PLANNING COMMISSION

HEARING DATE: August 14, 2017

PROJECT PLANNER: Andrew Chamberlain
Phone No.: (559) 713-4003
E-Mail: andrew.chamberlain@visalia.city

SUBJECT: Variance No. 2017-16: A request by California Water Service Company to allow a variance to the maximum height limit in the rear yard of an R-1-5 (Single-family Residential) zoned property, for the installation of three water treatment tanks. The site is located at 1622 S. Demaree Street. (APN: 095-232-009).

STAFF RECOMMENDATION

Staff recommends that the Planning Commission approve Variance No. 2017-16, as conditioned, based upon the conditions and findings in Resolution No. 2017-53. Staff's recommendation is based on the required variance findings and the project's consistency with the policies and intent of the City's General Plan and Zoning Ordinance.

RECOMMENDED MOTION

I move to approve Variance No. 2017-16, as conditioned, based on the findings and conditions in Resolution No. 2017-53.

PROJECT DESCRIPTION

Variance No. 2017-16 is a request by California Water Service Company (Cal Water) to exceed the 12-foot maximum height limit within the 25-foot rear yard setback area for an R-1-5 zoned parcel. Cal Water is requesting to install three tanks, two Granular Activated Carbon (GAC) wellhead treatment vessels within 8-feet of the rear property line, and 5-feet from the south property line (see Exhibit "A"). Each vessel has a vertical height of 19-feet, 8-inches, and are 10-feet in diameter (see Exhibit "B"). One Fluidizing Water Holding Tank would be located approximately 6-feet from the rear property line as shown in Exhibit "A", and would be 16-feet 1-inch high. The three new vessels are located behind the existing pump building at well site VIS-W-040-01, which is located at 1622 S. Demaree Street.

Cal Water is being required to comply with new State-adopted regulations relating to groundwater and traces of 1, 2, 3 trichloropropane (TCP), a byproduct in the manufacture of soil fumigants. In the Visalia City limits Cal Water has 11 wells that are subject to the new legislation and must have upgrades completed by January 1, 2018.

The impact to the existing wells in Visalia is that Cal Water must install new equipment on sites that are already developed with a pump station. The subject site, like most of Cal Water's sites, contains equipment enclosed in a building on a parcel located in a



residential neighborhood that could otherwise accommodate a single-family residence. The parcel is 7,400 square feet in size and, like the residences abutting the Cal Water Pump Site, is subject to R-1-5 zoning standards.

The improvements to the site will include new piping leading to the new GAC treatment vessels. Due to separation requirements and site constraints, the vessels will be located in the rear yard setback area. The vessels will be located 8-feet from the rear property line (east) and 5-feet from the side property line (south). Cal Water is also proposing to plant Italian cypress trees along the north, south and east boundaries of the site to screen the new vessels from adjacent residential properties as shown in Exhibit "A". According to the site plan, disposal of fluidizing water is proposed to be by connection to the existing City storm drain system.

Cal Water has prepared a response to the five required variance findings to support their request, included as Exhibit "C". The applicant's findings explain State regulations require the installation of wellhead treatment equipment within a short timeframe.

BACKGROUND INFORMATION

General Plan Land Use Designation	Low Density Residential
Zoning	R-1-5 – Single Family Residential
Surrounding Zoning and Land Use	North: R-1-5 – Single Family Residential homes South: R-1-5 – Single Family Residential homes East: R-1-5 – Single Family Residential homes West: R-1-5 – Single Family Residential homes
Environmental Review	Categorical Exemption No. 2017-58
Special District	None
Site Plan Review	2017-103

RELATED PLANS & POLICIES

Please see attached summary of related plans and policies.

RELATED ACTIONS

Conditional Use Permit No. 202 was approved by the Planning Commission in 1972. The Conditional Use Permit was a request by California Water Service Company for a well and pump site on the subject site. Staff has determined that the proposed addition of new equipment to the site will not result in an inconsistency of the CUP's conditions of approval.

Variance No's. 2017-10, 11, 12, and 13: At the July, 24, 2017 Planning Commission meeting, the Commission approved four similar variance requests for the installation of tank vessels in the rear yard areas of water well sites, in or adjacent to residential development.

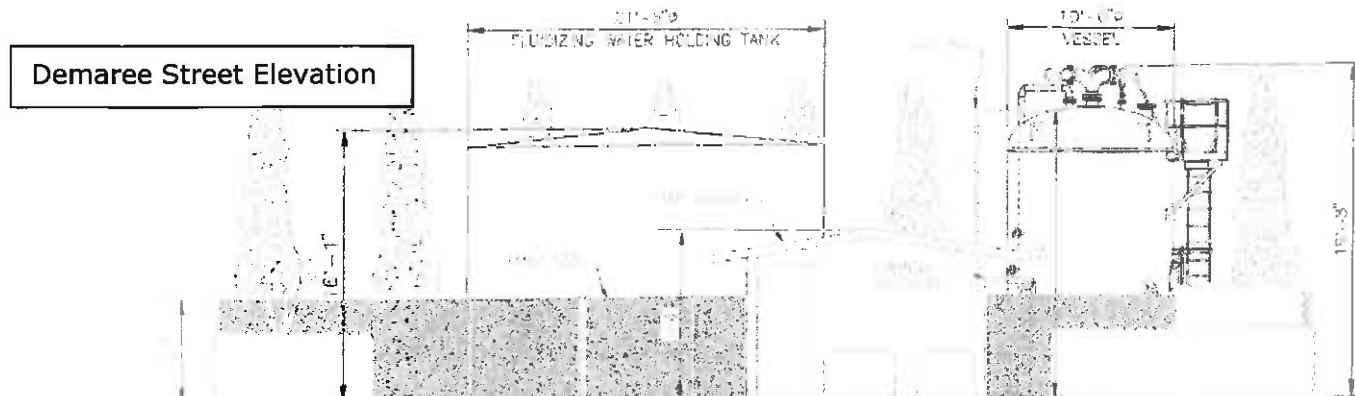

PROJECT EVALUATION

Staff supports the variance to increase the height limit in the rear setback from 12 feet to 19'-8" for the installation of three treatment vessels, based on the project's proposed findings (see Exhibit "C").

Rear Yard Setback Requirements

The rear yard setback for R-1-5 zoned lots is 25 feet. Within this setback area, accessory structures are allowed subject to development standards that include a height limit of 12 feet. All of the subject site's existing equipment is currently located within the buildable area of the site and meets all setback requirements.

Staff is recommending approval of the variance largely based on the necessity of adding new equipment to the site in order to maintain a public service to the City. Although there are no other known sites in the vicinity wherein structures in the rear yard exceed the height limit, the nature and use of this site as a pumping station represents an exceptional circumstance.

Screening: Staff's recommendation is supported by the fact that the size and height of the vessels are not out of character with the size of residences in the neighborhood, and that screening will be added to the site in the form of Italian Cypress trees planted at six-foot intervals. Staff has included Condition No. 2, requiring that the Italian Cypress trees be planted and maintained to provide a visual screen for the adjacent properties.

Required Variance Findings

The Planning Commission is required to make five findings before a variance can be granted. The applicant has provided response to the variance findings and staff has included the analysis for each finding below. The applicant's responses to the variance findings are also included in Exhibit "C".

1. *That strict or literal interpretation and enforcement of the specified regulation would result in practical difficulty or unnecessary hardship inconsistent with the objectives of the zoning ordinance;*

Applicant Finding: The proposed treatment configuration has been determined in order to the equipment on the project site while allowing for continued maintenance operations at the existing well. Due to the short time line for this project, the treatment vessels as shown have already be ordered from the vessel manufacture and cannot be changed.

Staff Analysis: Staff finds that the applicant has an obligation to provide a public service to the community and is being required to upgrade the pumping station in order to adapt to new regulations. The location of the equipment is a result of the required equipment necessary to filter out particulates from the City's ground drinking water.

2. *That there are exceptional or extraordinary circumstances or conditions applicable to the property involved or to the intended use of the property which do not apply generally to other properties classified in the same zone;*

Applicant Findings: The use of the property as an existing well site is unique as compared to other properties classified in the same zone. The need for the installation of wellhead treatment equipment is an exceptional or extraordinary condition that does not apply to other properties classified in the same zone.

Staff Analysis: Staff concurs that the use of the property as a pumping station is an extraordinary circumstance being that all uses surrounding the site are residential and for private use. The State requirement to upgrade pumping stations in order to adapt to new regulations also represents an extraordinary circumstance in that the applicant must be able to fit the equipment on the existing project site while allowing for continued use of a public service on the site. There is also an exceptional circumstance in that the site does not contain any occupied structures, meaning the allowance of equipment in access of height will not negatively impact the privacy on surrounding parcels.

3. That strict or literal interpretation and enforcement of the specified regulation would deprive the applicant of privileges enjoyed by the owners of other properties classified in the same zone;

Applicant Findings: The use of the property as an existing well site is unique as compared to other properties classified in the same zone. The strict or literal interpretation of the specified regulation would impede Cal Water's ability to provide potable water to the community that is in compliance with State DDW regulations.

Staff Analysis: Staff concurs that the use of the property as an existing well site is unique as compared to other properties classified in the same zone. The strict enforcement of regulations would deprive the applicant from continuing to use the property for its permitted and intended use.

4. That the granting of the variance will not constitute a grant of special privilege inconsistent with the limitations on other properties classified in the same zone;

Applicant Finding: The use of the property as an existing well site is unique as compared to other properties classified in the same zone. The installation of wellhead treatment equipment would not constitute a grant of special privilege inconsistent with the limitations on other properties classified in the same zone.

Staff Analysis: Staff finds that the granting of a deviation from height codes for structures will not constitute a grant of special privilege inconsistent with the limitations on other properties classified in the same zone. The addition of new vessels on the site represents an extension of the site's primary intended use. At the height of 19'-8", the vessels would meet the site's height limit and other development standards if located within the buildable area of the site. However, due to the equipment required to remove TCP from ground water, and being surrounded by developed properties, the vessels cannot be located within the buildable area. Other properties classified in the same zone have been able to fit the primary use (i.e. residence) within the buildable area of the lot.

5. That the granting of the variance will not be detrimental to the public health, safety or welfare, or materially injurious to properties or improvements in the vicinity.

Applicant Finding: The granting of the requested variance will allow for GAC treatment to remove TCP from the community's water supply. This is a benefit to the properties and improvements in the vicinity of the project site.

Staff Analysis: Staff concurs that the variance will not be detrimental to the public health, safety or welfare, or materially injurious to properties or improvements in the vicinity, and will in fact help to improve public health to properties and improvements in the vicinity.

Environmental Review

The requested action is considered Categorical Exempt under Section 15305 of the Guidelines for the Implementation of the California Environmental Quality Act (CEQA). (Categorical Exemption No. 2017-58).

Projects determined to meet this classification consist of minor alterations in land use limitations in areas with an average slope of less than twenty (20) percent, which do not result in any changes in land use or density, including but not limited to minor lot line adjustments, side yard, and setback variances not resulting in the creation of any new parcel.

RECOMMENDED FINDINGS

1. That strict or literal interpretation and enforcement of the specified regulation would result in practical difficulty or unnecessary hardship inconsistent with the objectives of the zoning ordinance.

The applicant has an obligation to provide a public service to the community and is being required to upgrade the pumping station in order to adapt to new regulations. The location of the equipment is a result of the required equipment necessary to filter out particulates from the City's ground drinking water.

2. That there are exceptional or extraordinary circumstances or conditions applicable to the property involved or to the intended use of the property which do not apply generally to other properties classified in the same zone.

The use of the property as a pumping station is an extraordinary circumstance being that all uses surrounding the site are residential and for private use. The State requirement to upgrade pumping stations in order to adapt to new regulations also represents an extraordinary circumstance in that the applicant must be able to fit the equipment on the existing project site while allowing for continued use of a public service on the site. There is also an exceptional circumstance in that the site does not contain any occupied structures, meaning the allowance of equipment in access of height will not negatively impact the privacy on surrounding parcels.

3. That strict or literal interpretation and enforcement of the specified regulation would deprive the applicant of privileges enjoyed by the owners of other properties classified in the same zone.

The use of the property as an existing well site is unique as compared to other properties classified in the same zone. The strict enforcement of regulations would deprive the applicant from continuing to use the property for its permitted and intended use.

4. That the granting of the variance will not constitute a grant of special privilege inconsistent with the limitations on other properties classified in the same zone.

The granting of a deviation from height codes for structures will not constitute a grant of special privilege inconsistent with the limitations on other properties classified in the same zone. The addition of new vessels on the site represents an extension of the site's primary intended use. At the height of 19'-8", the vessels would meet the site's height limit and other development standards if located within the buildable area of the site. However, due to the equipment required to remove TCP from ground water, and being surrounded by developed properties, the vessels cannot be located within the buildable area. Other properties classified in the same zone have been able to fit the primary use (i.e. residence) within the buildable area of the lot.

5. *That the granting of the variance will not be detrimental to the public health, safety or welfare, or materially injurious to properties or improvements in the vicinity.*

The variance will not be detrimental to the public health, safety or welfare, or materially injurious to properties or improvements in the vicinity, and will in fact help to improve public health to properties and improvements in the vicinity.

6. That the project is considered Categorically Exempt under Section 15305 of the Guidelines for Implementation of CEQA (Categorical Exemption No. 2017-58).

RECOMMENDED CONDITIONS OF APPROVAL

1. That the project be developed in substantial compliance and be consistent with the comments of Site Plan Review item no. 2017-103.
2. That the site improvements, including the addition of Italian Cypress trees to screen the equipment, shall be developed consistent with the site plan included as Exhibit "A". The Italian Cypress trees shall be maintained at all times and shall be replaced if the trees become dead.
3. That the treatment vessel shall match the elevation plan in Exhibit "B".
4. That all other federal, state, regional, and county laws and city codes and ordinances be complied with.

APPEAL INFORMATION

According to the City of Visalia Zoning Ordinance Section 17.02.145, an appeal to the City Council may be submitted within ten days following the date of a decision by the Planning Commission. An appeal form with applicable fees shall be filed with the City Clerk at 220 N. Santa Fe Street, Visalia, CA 93292. The appeal shall specify errors or abuses of discretion by the Planning Commission, or decisions not supported by the evidence in the record. The appeal form can be found on the city's website www.visalia.city or from the City Clerk.

Attachments:

- Related Plans and Policies
- Resolution No. 2017-53
- Exhibit "A" – Site Plan
- Exhibit "B" – Elevation – Demaree Street
- Exhibit "C" – Variance Findings Prepared by Applicant
- Site Plan Review No. 2017-103 Comments
- General Plan Land Use Map
- Zoning Map
- Aerial Map
- Location Sketch

RELATED PLANS AND POLICIES

Zoning Ordinance Chapter 17.12 SINGLE-FAMILY RESIDENTIAL ZONE

17.12.100 Rear yard.

In the R-1 single-family residential zones, the minimum yard shall be twenty-five (25) feet, subject to the following exceptions:

A. On a corner or reverse corner lot the rear yard shall be twenty-five (25) feet on the narrow side or twenty (20) feet on the long side of the lot. The decision as to whether the short side or long side is used as the rear yard area shall be left to the applicant's discretion as long as a minimum area of one thousand five hundred (1,500) square feet of usable rear yard area is maintained. The remaining side yard to be a minimum of five feet.

B. Accessory structures not exceeding twelve (12) feet may be located in the required rear yard but not closer than three feet to any lot line provided that not more than twenty (20) percent of the area of the required rear yard shall be covered by structures enclosed on more than one side and not more than forty (40) percent may be covered by structures enclosed on only one side. On a reverse corner lot an accessory structure shall not be located closer to the rear property line than the required side yard on the adjoining key lot. An accessory structure shall not be closer to a side property line adjoining key lot and not closer to a side property line adjoining the street than the required front yard on the adjoining key lot.

C. Main structures may encroach up to five feet into a required rear yard area provided that such encroachment does not exceed one story and that a usable, open, rear yard area of at least one thousand five hundred (1,500) square feet shall be maintained. Such encroachment and rear yard area shall be approved by the city planner prior to issuing building permits.

17.12.110 Height of structures.

In the R-1 single-family residential zone, the maximum height of a permitted use shall be thirty-five (35) feet, with the exception of structures specified in Section 17.12.100(B).

Zoning Ordinance Chapter 17.42 VARIANCES AND EXCEPTIONS

17.42.010 Variance purposes.

The city planning commission may grant variances in order to prevent unnecessary hardships that would result from a strict or literal interpretation and enforcement of certain regulations prescribed by this title. A practical difficulty or unnecessary hardship may result from the size, shape or dimensions of a site or the location of existing structures thereon, from geographic, topographic or other physical conditions on the site or in the immediate vicinity, or from population densities, street locations or traffic conditions in the immediate vicinity. The power to grant variances does not extend to use regulations, because the flexibility necessary to avoid results inconsistent with the objectives of the zoning ordinance is provided by the conditional use provisions of this title. (Prior code § 7555)

17.42.020 Exception purposes.

A. The planning commission may grant exceptions to ordinance requirements where there is a justifiable cause or reason; provided, however, that it does not constitute a grant of special privilege inconsistent with the provisions and intentions of this title.

B. The planning commission may grant exceptions or modifications to site development standards and zoning in accordance with the provisions of Chapter 17.32, Article 2, density bonuses

and other incentives for lower and very low income households and housing for senior citizens. (Prior code § 7556)

17.42.030 Variance powers of city planning commission.

The city planning commission may grant variances to the regulations prescribed by this title with respect to fences and walls, site area, width, frontage coverage, front yard, rear yard, side yards, height of structures, distance between structures and off-street parking facilities, in accordance with the procedures prescribed in this chapter. (Prior code § 7557)

17.42.040 Exception powers of city planning commission.

The city planning commission may grant exceptions to the regulations prescribed in this title, with respect to the following, consistent with the provisions and intentions of this title:

- A. Second dwelling units, pursuant to Sections 17.12.140 through 17.12.200;
- B. Downtown building design criteria, pursuant to Section 17.58.090;
- C. Fences, walls and hedges; and
- D. Upon the recommendation of the historic preservation advisory board and/or the downtown design review board, site area, width, frontage, coverage, front yard, rear yard, side yards, height of structures, distance between structures and off-street parking facilities;
- E. In accordance with Chapter 17.32, Article 2, density bonuses, may grant exceptions or modifications to site development standards and/or zoning codes. (Prior code § 7558)

17.42.050 Application procedures.

A. Application for a variance or exception shall be made to the city planning commission on a form prescribed by the commission and shall include the following data:

1. Name and address of the applicant;
2. Statement that the applicant is the owner of the property, is the authorized agent of the owners, or is or will be the plaintiff in an action in eminent domain to acquire the property involved;
3. Address and legal description of the property;
4. Statement of the precise nature of the variance or exception requested and the hardship or practical difficulty which would result from the strict interpretation and enforcement of this title;
5. The application shall be accompanied by such sketches or drawings which may be necessary to clearly show applicant's proposal;
6. Additional information as required by the historic preservation advisory board;
7. When reviewing requests for an exception associated with a request for density bonus as provided in Chapter 17.32, Article 2, the applicant shall submit copies of the comprehensive development plan, sketches and plans indicating the nature of the request and written justification that the requested modifications result in identifiable cost reductions required for project to reach target affordability.

B. The application shall be accompanied by a fee set by resolution of the city council sufficient to cover the cost of handling the application. (Prior code § 7559)

17.42.060 Hearing and notice.

- A. The city planning commission shall hold a public hearing on an application for a variance.
- B. Notice of a public hearing shall be given not less than ten days or more than thirty (30) days prior to the date of the hearing by mailing a notice of the time and place of the hearing to property owners within three hundred (300) feet of the boundaries of the area occupied or to be occupied by the use which is the subject of the hearing. (Prior code § 7560)

17.42.070 Investigation and report.

The city planning staff shall make an investigation of the application and shall prepare a report thereon which shall be submitted to the city planning commission. (Prior code § 7561)

17.42.080 Public hearing procedure.

At a public hearing the city planning commission shall review the application and the statements and drawings submitted therewith and shall receive pertinent evidence concerning the variance, particularly with respect to the findings prescribed in Section 17.42.090. (Prior code § 7562)

17.42.090 Variance action of the city planning commission.

A. The city planning commission may grant a variance to a regulation prescribed by this title with respect to fences and walls, site area, width, frontage, coverage, front yard, rear yard, side yards, height of structures, distances between structures or landscaped areas or in modified form if, on the basis of the application, the report of the city planning staff or the evidence submitted, the commission makes the following findings:

1. That strict or literal interpretation and enforcement of the specified regulation would result in practical difficulty or unnecessary hardship inconsistent with the objectives of the zoning ordinance;

2. That there are exceptional or extraordinary circumstances or conditions applicable to the property involved or to the intended use of the property which do not apply generally to other properties classified in the same zone;

3. That strict or literal interpretation and enforcement of the specified regulation would deprive the applicant of privileges enjoyed by the owners of other properties classified in the same zone;

4. That the granting of the variance will not constitute a grant of special privilege inconsistent with the limitations on other properties classified in the same zone;

5. That the granting of the variance will not be detrimental to the public health, safety or welfare, or materially injurious to properties or improvements in the vicinity.

B. The city planning commission may grant a variance to a regulation prescribed by this title with respect to off-street parking facilities, if, on the basis of the application, the report of the city planner or the evidence submitted the commission makes the findings prescribed in subsection (A)(1) of this section and that the granting of the variance will not result in the parking of vehicles on public streets in such a manner as to interfere with the free flow of traffic on the streets.

C. A variance may be revocable, may be granted for a limited time period, or may be granted subject to such conditions as the commission may prescribe.

D. The city planning commission may deny a variance application. (Prior code § 7563)

17.42.100 Exception action of the city planning commission.

A. The city planning commission may grant an exception to a regulation prescribed by this title with respect to fences and walls, and, upon recommendation of the historic preservation advisory board, site area, width, frontage, coverage, front yard, rear yard, side yards, height of structures, distances between structures or landscaped areas, provided that all of the following criteria is applicable:

1. That the granting of the fence exception will not be detrimental to the public health, safety or welfare, or materially injurious to properties or improvements in the vicinity;

2. That the granting of the exception does not create an obstructed visibility that will interfere with traffic safety in the public right-of-way or to adjacent properties;

3. That the exception proposal becomes an integral part of the existing site development (e.g., design, material, contour, height, distance, color, texture).

B. The city planning commission may grant exceptions or modifications to zoning code requirements in accordance with the provisions of Chapter 17.32, Article 2, density bonuses. The granting of the exception shall become effective upon

the granting of the density bonus by the city council. (Prior code § 7564)

17.42.110 Appeal to city council.

A. Within five (5) working days following the date of a decision of the city planning commission on a variance or exception application, the decision may be appealed to the city council by the applicant or any other interested party. An appeal shall be made on a form prescribed by the commission and shall be filed with the city clerk. The appeal shall specify errors or abuses of discretion by the commission, or decisions not supported by the evidence in the record.

B. The city clerk shall give notice to the applicant and the appellant (if the applicant is not the appellant) and may give notice to any other interested party of the time when the appeal will be considered by the city council. (Ord. 2001-13 § 4 (part), 2001: prior code § 7565)

17.42.120 Action of city council.

A. The city council shall review and may affirm, reverse or modify a decision of the city planning commission on a variance or exception application; provided, that if a decision denying a variance or exception is reversed or a decision granting a variance or exception is modified, the city council shall, on the basis of the record transmitted by the city planner and such additional evidence as may be submitted, make the findings prerequisite to the granting of a variance or exception as prescribed in Section 17.42.090(A) or (B), or 17.42.100(A), whichever is applicable.

B. A variance which has been the subject of an appeal to the city council shall become effective immediately after review and affirmative action by the city council. (Ord. 9605 § 30 (part), 1996: prior code § 7566)

17.42.130 Lapse of variance.

A variance shall lapse and become void one year following the date on which the variance became effective, unless prior to the expiration of one year, a building permit is issued by the building official and construction is commenced and diligently pursued toward completion on the site which was the subject of the variance application, or a certificate of occupancy is issued by the building official for the site or structure which was the subject of the variance application. A variance may be renewed for an additional period of one year; provided, that prior to the expiration of one year from the date when the variance became effective, an application for renewal of the variance is made to the commission. The commission may grant or deny an application for renewal of a variance. (Prior code § 7567)

17.42.140 Revocation.

A variance granted subject to a condition or conditions shall be revoked by the city planning commission if the condition or conditions are not complied with. (Prior code § 7568)

17.42.150 New application.

Following the denial of a variance application or the revocation of a variance, no application for the same or substantially the same variance on the same or substantially the same site shall be filed within one year of the date of denial of the variance application or revocation of the variance. (Prior code § 7569)

RESOLUTION NO. 2017-53

A RESOLUTION OF THE PLANNING COMMISSION OF THE CITY OF VISALIA APPROVING VARIANCE NO. 2017-16, A REQUEST BY CALIFORNIA WATER SERVICE COMPANY TO ALLOW A VARIANCE TO THE MAXIMUM HEIGHT LIMIT IN THE REAR YARD OF AN R-1-5 (SINGLE-FAMILY RESIDENTIAL) ZONED PROPERTY, FOR THE INSTALLATION OF THREE WATER TREATMENT TANKS. THE SITE IS LOCATED AT 1622 S. DEMAREE STREET. (APN: 095-232-009)

WHEREAS, Variance No. 2017-16, is A request by California Water Service Company to allow a variance to the maximum height limit in the rear yard of an R-1-5 (Single-family Residential) zoned property, for the installation of three water treatment tanks. The site is located at 1622 S. Demaree Street. (APN: 095-232-009); and,

WHEREAS, the Planning Commission of the City of Visalia, after published notice scheduled a public hearing before said commission on August 14, 2017; and,

WHEREAS, the Planning Commission of the City of Visalia finds Variance No. 2017-14, as conditioned by staff, to be in accordance with Section 17.42 of the Zoning Ordinance of the City of Visalia based on the evidence contained in the staff report and testimony presented at the public hearing; and,

WHEREAS, the Planning Commission of the City of Visalia finds the project to be Categorically Exempt consistent with the California Environmental Quality Act (CEQA) and City of Visalia Environmental Guidelines.

NOW, THEREFORE, BE IT RESOLVED that the project is exempt from further environmental review pursuant to CEQA Section 15305.

NOW, THEREFORE, BE IT FURTHER RESOLVED that the Planning Commission of the City of Visalia makes the following specific finding based on the evidence presented:

1. *That strict or literal interpretation and enforcement of the specified regulation would result in practical difficulty or unnecessary hardship inconsistent with the objectives of the zoning ordinance.*

The applicant has an obligation to provide a public service to the community and is being required to upgrade the pumping station in order to adapt to new regulations. The location of the equipment is a result of the required equipment necessary to filter out particulates from the City's ground drinking water.

2. *That there are exceptional or extraordinary circumstances or conditions applicable to the property involved or to the intended use of the property which do not apply generally to other properties classified in the same zone.*

The use of the property as a pumping station is an extraordinary circumstance being that all uses surrounding the site are residential and for private use. The State

requirement to upgrade pumping stations in order to adapt to new regulations also represents an extraordinary circumstance in that the applicant must be able to fit the equipment on the existing project site while allowing for continued use of a public service on the site. There is also an exceptional circumstance in that the site does not contain any occupied structures, meaning the allowance of equipment in access of height will not negatively impact the privacy on surrounding parcels.

3. That strict or literal interpretation and enforcement of the specified regulation would deprive the applicant of privileges enjoyed by the owners of other properties classified in the same zone.

The use of the property as an existing well site is unique as compared to other properties classified in the same zone. The strict enforcement of regulations would deprive the applicant from continuing to use the property for its permitted and intended use.

4. That the granting of the variance will not constitute a grant of special privilege inconsistent with the limitations on other properties classified in the same zone.

The granting of a deviation from height codes for structures will not constitute a grant of special privilege inconsistent with the limitations on other properties classified in the same zone. The addition of new vessels on the site represents an extension of the site's primary intended use. At the height of 19'-8", the vessels would meet the site's height limit and other development standards if located within the buildable area of the site. However, due to the equipment required to remove TCP from ground water, and being surrounded by developed properties, the vessels cannot be located within the buildable area. Other properties classified in the same zone have been able to fit the primary use (i.e. residence) within the buildable area of the lot.

5. That the granting of the variance will not be detrimental to the public health, safety or welfare, or materially injurious to properties or improvements in the vicinity.

The variance will not be detrimental to the public health, safety or welfare, or materially injurious to properties or improvements in the vicinity, and will in fact help to improve public health to properties and improvements in the vicinity.

6. That the project is considered Categorical Exempt under Section 15305 of the Guidelines for Implementation of CEQA (Categorical Exemption No. 2017-58).

BE IT FURTHER RESOLVED that the Planning Commission hereby approves Variance No. 2017-16, as conditioned, on the real property herein above described in accordance with the terms of this resolution under the provision of Section 17.48.110 of the Ordinance Code of the City of Visalia, subject to the following conditions:

1. That the project be developed in substantial compliance and be consistent with the comments of Site Plan Review item no. 2017-103.

2. That the site improvements, including the addition of Italian Cypress trees to screen the equipment, shall be developed consistent with the site plan included as Exhibit "A". The Italian Cypress trees shall be maintained at all times and shall be replaced if the trees become dead.
3. That the treatment vessel shall match the elevation plan in Exhibit "B".
4. That all other federal, state, regional, and county laws and city codes and ordinances be complied with.

ENGINEERING



DEPARTMENT

PROJECT NO. VIS-17-023-01
DATE 11/15/17
DRAWN BY
CHECKED BY

SCALE
NO SCALE
DATE
PROJECT NO.

DATE
PROJECT NO.

DATE
PROJECT NO.

DATE
PROJECT NO.

DATE
PROJECT NO.

DATE
PROJECT NO.

DATE
PROJECT NO.

DATE
PROJECT NO.

DATE
PROJECT NO.

DATE
PROJECT NO.

DATE
PROJECT NO.

STATION VIS-W-023-01
TCP TREATMENT STREET VIEW PROFILE
1920 WEST ASHLAND AVE., VISALIA, CA

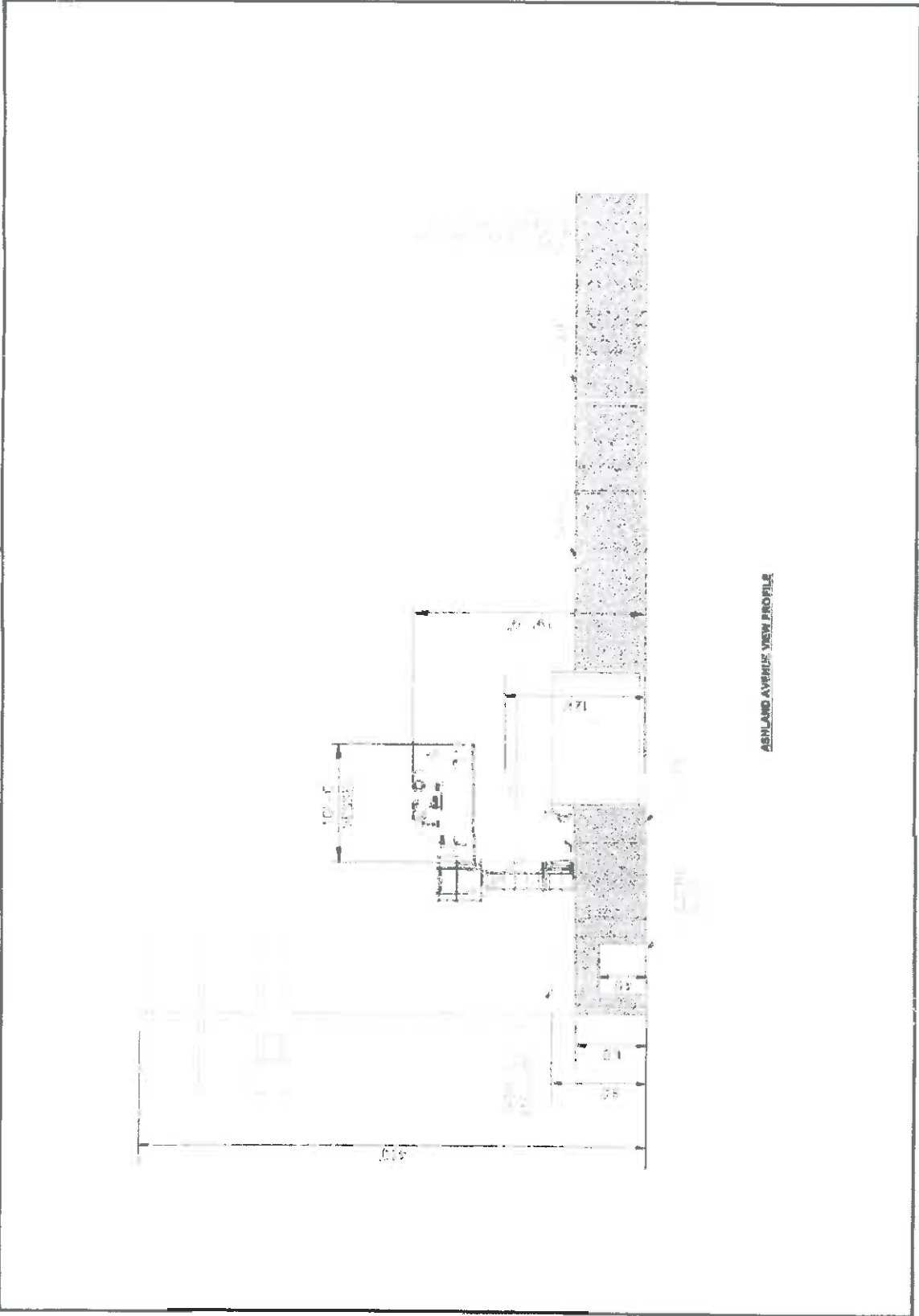

ASHLAND AVENUE VIEW PROFILE



STATION NO. 17-001-001
TOP TREATMENT SITE PLAN
1000 WEST ASHLAND AVE., VISTA, CA

DATE	10/10/17
PROJECT	1000 WEST ASHLAND AVE., VISTA, CA
CLIENT	WESTVIEW COMMUNITY DEVELOPMENT
DESIGNER	ASCOM
APPROVED BY	[Signature]
SCALE	AS SHOWN
DATE	10/10/17

STATION NO. 17-001-001
 TOP TREATMENT SITE PLAN
 1000 WEST ASHLAND AVE., VISTA, CA



Notes:

1. All construction shall be in accordance with the approved plans and specifications.
2. All materials and workmanship shall be in accordance with the approved plans and specifications.
3. All work shall be completed within the specified time frame.

Exhibit "A"

TITLE:
STATION VIS-W-040-01
TCP TREATMENT SITE PLAN
1622 S. DEMAREE ST., VISALIA, CA 93277

- Legend**
- Property Line
 - Utility Line
 - Public Street
 - Public Sewer

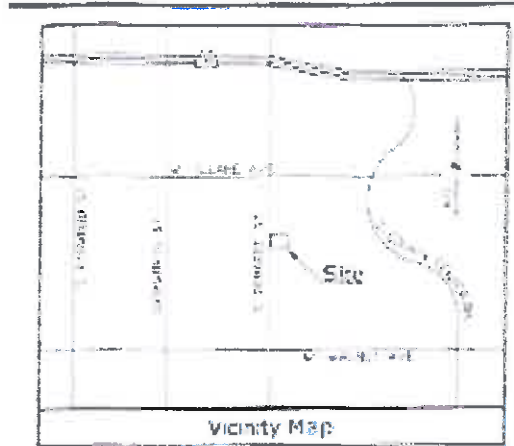

ENGINEERING



DEPARTMENT

REVISIONS

NO.	DATE	DESCRIPTION

6/18 2015

SHOWN TO BE ON
DATE PER 10/18/2015

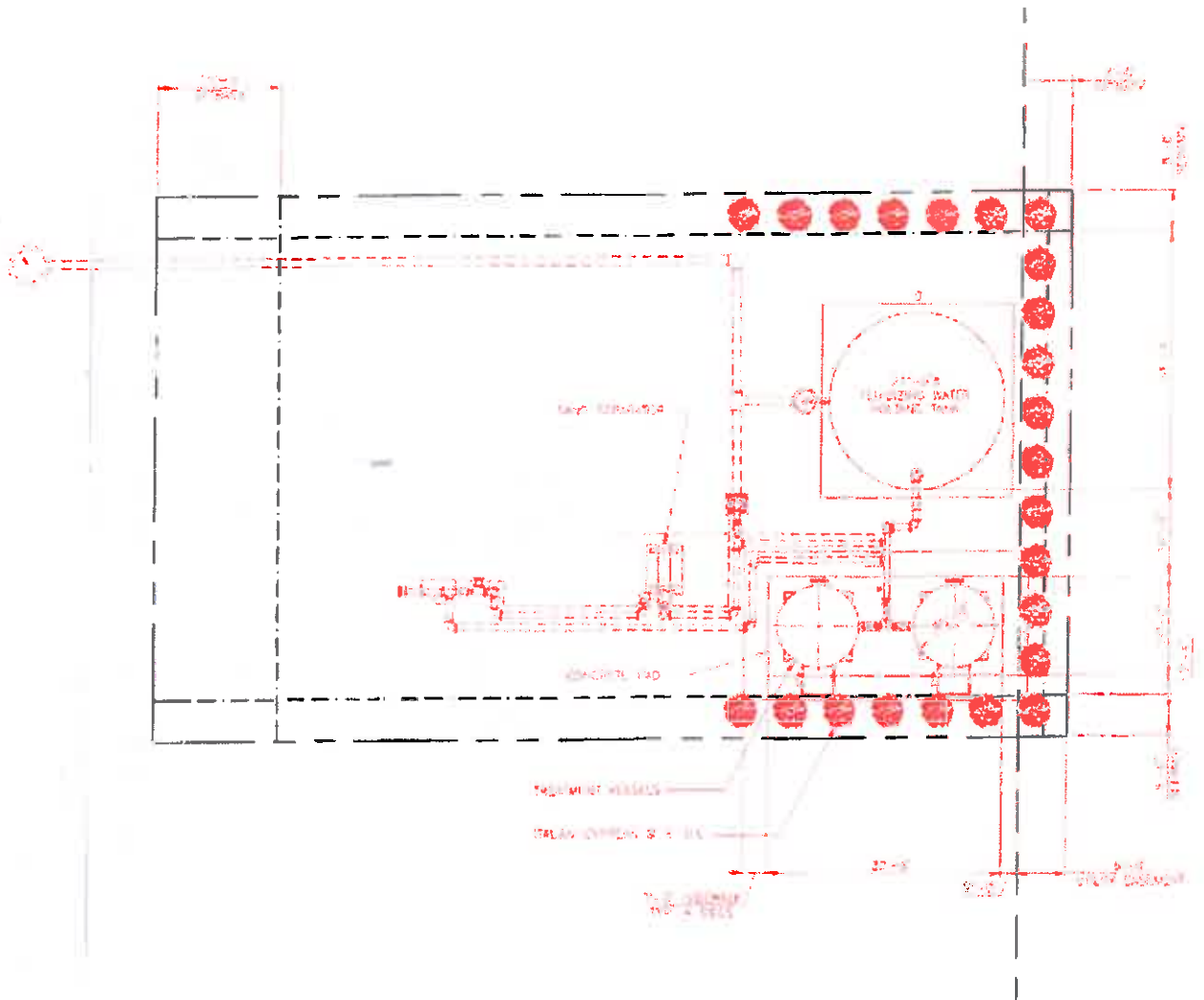

1 | **SITE PLAN**

Exhibit "A"

Exhibit "B"

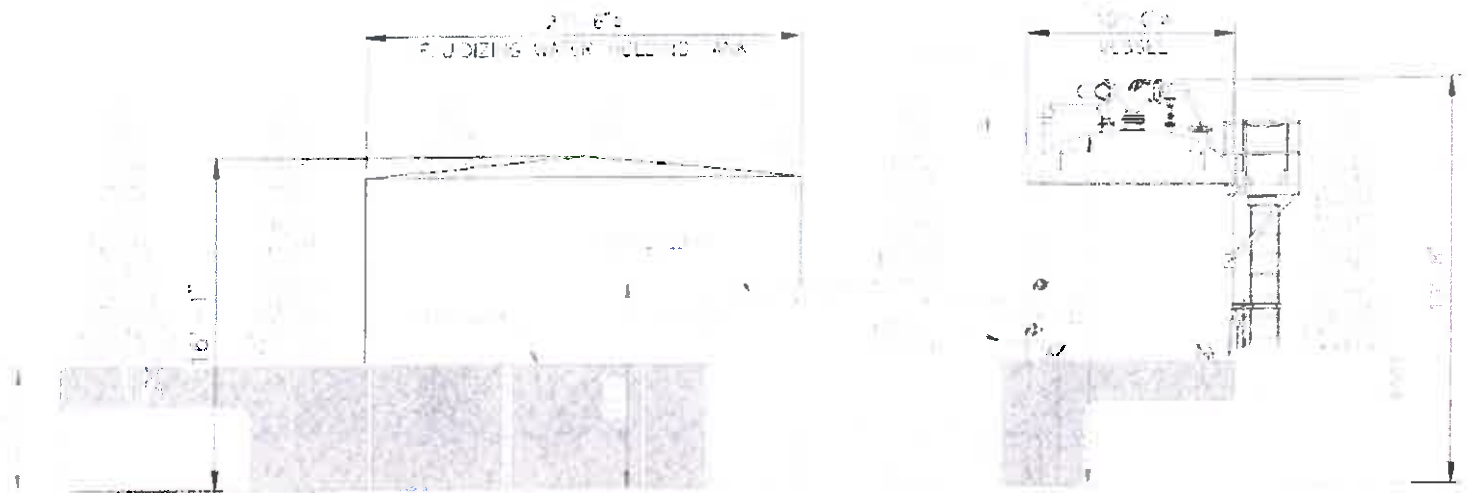

Proposed Elevation on Demaree Street



2015 Street View

Exhibit "B"

Exhibit "C"

Project Description:

The project consists of the addition of granular activated carbon (GAC) wellhead treatment equipment for the removal of 1,2,3 trichloropropane (TCP) at an existing well site. The California Division of Drinking Water (DDW) has published a draft Maximum Contaminant Level (MCL) to regulate TCP with implementation of the new regulation beginning in early 2018. One pair of 10' diameter vessels is proposed as shown on the attached Site Plan.

The only change to existing well operations will be during the change out of GAC in the vessels, which will occur approximately once per year. This will consist of one truck to deliver new and remove spent GAC and the subsequent fluidizing of the new GAC in the vessels. Fluidizing operations will take approximately 30 minutes per vessel and generate a total volume of approximately 32,000 gallons per pair of 10' vessels. Disposal of fluidizing water is proposed to be the same as for current well flushing operations – to W. Ashland Avenue following Cal Water's standard operating procedures for disposal operations.

Italian Cypress trees are proposed to be planted along the east boundary of the site to screen the equipment from adjacent property. A Street View Profile sheet is also attached to show the proposed improvements.

Variance Request:

A zoning variance is requested to allow the proposed 19'-9" high vessels to be installed within the R-1-5 zone at the locations shown on the Site Plan.

Justification for Findings:

1. That strict or literal interpretation and enforcement of the specified regulation would result in practical difficulty or unnecessary hardship inconsistent with the objectives of the zoning ordinance:

The proposed treatment configuration has been determined in order to fit the equipment on the project site while allowing for continued maintenance operations at the existing well. Due to the short time line for this project, the treatment vessels as shown have already been ordered from the vessel manufacturer and cannot be changed.

2. That there are exceptional or extraordinary circumstances or conditions applicable to the property involved which do not apply generally to other properties classified in the same zone:

The use of the property as an existing well site is unique as compared to other properties classified in the same zone. The need for the installation of wellhead treatment equipment is an exceptional or extraordinary condition that does not apply to other properties classified in the same zone.

3. That strict or literal interpretation and enforcement of the specified regulation would deprive the applicant of privileges enjoyed by the owners of other properties classified in the same zone:

The use of the property as an existing well site is unique as compared to other properties classified in the same zone. The strict or literal interpretation of the specified regulation would impede Cal Water's ability to provide potable water to the community that is in compliance with State DDW regulations.

4. That the granting of the variance will not constitute a grant of special privilege inconsistent with the limitations on other properties classified in the same zone:

The use of the property as an existing well site is unique as compared to other properties classified in the same zone. The installation of wellhead treatment equipment would not constitute a grant of special privilege inconsistent with the limitations on other properties classified in the same zone.

5. That the granting of the variance will not be detrimental to the public health, safety, or welfare, or materially injurious to properties or improvements in the vicinity:

The granting of the requested variance will allow for GAC treatment to remove TCP from the community's water supply. This is a benefit to the properties and improvements in the vicinity of the project site.

Exhibit "C"

NOTICE OF EXEMPTION

City of Visalia
315 E. Acequia Ave.
Visalia, CA 93291

To: County Clerk
County of Tulare
County Civic Center
Visalia, CA 93291-4593

Variance No. 2017-16

PROJECT TITLE

The project site is located at 1622 S. Demaree Street (APN: 095-232-009).

PROJECT LOCATION

Visalia

PROJECT LOCATION - CITY

Tulare

COUNTY

A request to allow a variance to the maximum height limit in the rear yard of an R-1-5 (Single-family Residential) zoned property, for the installation of four new GAC vessels.

DESCRIPTION - Nature, Purpose, & Beneficiaries of Project

City of Visalia, 315 E. Acequia Avenue, Visalia, CA 93291, andrew.chamberlain@visalia.city

NAME OF PUBLIC AGENCY APPROVING PROJECT

California Water Service Co., 1720 N. First Street, San Jose, CA 95112; tkelly@calwater.com

NAME AND ADDRESS OF APPLICANT CARRYING OUT PROJECT

N/A

NAME AND ADDRESS OF AGENT CARRYING OUT PROJECT

EXEMPT STATUS: (Check one)

- Ministerial - Section 15073
 Emergency Project - Section 15071
 Categorical Exemption - State type and Section number: **Section 15305**
 Statutory Exemptions- State code number:

The project is characterized as a minor alteration to land use limitations that does not result in changes in land use or density.

REASON FOR PROJECT EXEMPTION

Andrew Chamberlain, Planner

CONTACT PERSON

(559) 713-4003

AREA CODE/PHONE

August 14, 2017

DATE

Paul Scheibel, AICP

ENVIRONMENTAL COORDINATOR



#6

MEETING DATE: MAY 31, 2017

SITE PLAN NO. 17-103

PARCEL MAP NO.

SUBDIVISION:

LOT LINE ADJUSTMENT NO.

Enclosed for your review are the comments and decisions of the Site Plan Review committee. Please review all comments since they may impact your project.

RESUBMIT Major changes to your plans are required. Prior to accepting construction drawings for building permit, your project must return to the Site Plan Review Committee for review of the revised plans.

During site plan design/policy concerns were identified, schedule a meeting with

Planning

Engineering prior to resubmittal plans for Site Plan Review.

Solid Waste

Parks and Recreation

Fire Dept.

REVISE AND PROCEED (see below)

A revised plan addressing the Committee comments and revisions must be submitted for Off-Agenda Review and approval prior to submitting for building permits or discretionary actions.

Submit plans for a building permit between the hours of 9:00 a.m. and 4:00 p.m., Monday through Friday.

Your plans must be reviewed by:

CITY COUNCIL

REDEVELOPMENT

PLANNING COMMISSION

PARK/RECREATION

HISTORIC PRESERVATION

OTHER: PUBLIC WORKS DEPT.

ADDITIONAL COMMENTS :

If you have any questions or comments, please call Jason Huckleberry at (559) 713-4259.

Site Plan Review Committee



**BUILDING/DEVELOPMENT PLAN
REQUIREMENTS
ENGINEERING DIVISION**

Jason Huckleberry 713-4259
 Adrian Rubalcaba 713-4271

ITEM NO: 6 DATE: MAY 31, 2017

SITE PLAN NO.: 17-103
PROJECT TITLE: CALIFORNIA WATER SERVICE
DESCRIPTION: ADDITION OF GRANULAR ACTIVATED CARBON
WELLHEAD WATER TREATMENT EQUIPMENT
AT EXISTING WELL SITES (R15) (X)
APPLICANT: CALIFORNIA WATER SERVICE
PROP OWNER: CALIF WATER SERVICE CO
LOCATION: 1622 S DEMAREE ST
APN: 095-232-009

SITE PLAN REVIEW COMMENTS

- REQUIREMENTS (indicated by checked boxes)
- Install curb return with ramp, with _____ radius;
- Install curb; gutter
- Drive approach size: Use radius return;
- Sidewalk: _____ width; _____ parkway width at
- Repair and/or replace any sidewalk across the public street frontage(s) of the subject site that has become uneven, cracked or damaged and may constitute a tripping hazard.
- Replace any curb and gutter across the public street frontage(s) of the subject site that has become uneven and has created areas where water can stand.
- Right-of-way dedication required. A title report is required for verification of ownership.
- Deed required prior to issuing building permit;
- City Encroachment Permit Required. **FOR ALL WORK IN THE PUBLIC RIGHT-OF-WAY**
Insurance certificate with general & auto liability (\$1 million each) and workers compensation (\$1 million), valid business license, and appropriate contractor's license must be on file with the City, and valid Underground Service Alert # provided prior to issuing the permit. Contact Encroachment Tech. at 713-4414.
- CalTrans Encroachment Permit required. CalTrans comments required prior to issuing building permit. Contacts: David Deel (Planning) 488-4088;
- Landscape & Lighting District/Home Owners Association required prior to approval of Final Map. Landscape & Lighting District will maintain common area landscaping, street lights, street trees and local streets as applicable. Submit completed Landscape and Lighting District application and filing fee a min. of 75 days before approval of Final Map.
- Landscape & irrigation improvement plans to be submitted for each phase. Landscape plans will need to comply with the City's street tree ordinance. The locations of street trees near intersections will need to comply with Plate SD-1 of the City improvement standards. A street tree and landscape master plan for all phases of the subdivision will need to be submitted with the initial phase to assist City staff in the formation of the landscape and lighting assessment district.
- Grading & Drainage plan required. If the project is phased, then a master plan is required for the entire project area that shall include pipe network sizing and grades and street grades. Prepared by registered civil engineer or project architect. All elevations shall be based on the City's benchmark network. Storm run-off from the project shall be handled as follows: a) directed to the City's existing storm drainage system; b) directed to a permanent on-site basin; or c) directed to a temporary on-site basin is required until a connection with adequate capacity is available to the City's storm drainage system. On-site basin: _____ : _____ maximum side slopes, perimeter fencing required, provide access ramp to bottom for maintenance.
- Grading permit is required for clearing and earthwork performed prior to issuance of the building permit.
- Show finish elevations. (Minimum slopes: A.C. pavement = 1%, Concrete pavement = 0.25%. Curb & Gutter = .020%, V-gutter = 0.25%)
- Show adjacent property grade elevations. A retaining wall will be required for grade differences greater than 0.5 feet at the property line.
- All public streets within the project limits and across the project frontage shall be improved to their full width, subject to available right of way, in accordance with City policies, standards and specifications.
- Traffic indexes per city standards:

- Install street striping as required by the City Engineer.
- Install landscape curbing (typical at parking lot planters).
- Minimum paving section for parking: 2" asphalt concrete paving over 4" Class 2 Agg. Base, or 4" concrete pavement over 2" sand.
- Design Paving section to traffic index of 5.0 min. for solid waste truck travel path.
- Provide "R" value tests: each at
- Written comments required from ditch company Contacts: James Silva 747-1177 for Modoc, Persian, Watson, Oakes, Flemming, Evans Ditch and Peoples Ditch; Jerry Hill 686-3425 for Tulare Irrigation Canal, Packwood and Cameron Creeks; Bruce George 747-5601 for Mill Creek and St. John's River.
- Access required on ditch bank, 15' minimum Provide wide riparian dedication from top of bank.
- Show Oak trees with drip lines and adjacent grade elevations. Protect Oak trees during construction in accordance with City requirements.
- A permit is required to remove oak trees. Contact Joel Hooyer at 713-4295 for an Oak tree evaluation or permit to remove. A pre-construction conference is required.
- Relocate existing utility poles and/or facilities.
- Underground all existing overhead utilities within the project limits. Existing overhead electrical lines over 50kV shall be exempt from undergrounding.
- Subject to existing Reimbursement Agreement to reimburse prior developer:
- Fugitive dust will be controlled in accordance with the applicable rules of San Joaquin Valley Air District's Regulation VIII. Copies of any required permits will be provided to the City.
- If the project requires discretionary approval from the City, it may be subject to the San Joaquin Valley Air District's Rule 9510 Indirect Source Review per the rule's applicability criteria. A copy of the approved AIA application will be provided to the City.
- If the project meets the one acre of disturbance criteria of the State's Storm Water Program, then coverage under General Permit Order 2009-0009-DWQ is required and a Storm Water Pollution Prevention Plan (SWPPP) is needed. A copy of the approved permit and the SWPPP will be provided to the City.
- Comply with prior comments. Resubmit with additional information. Redesign required.

Additional Comments:

1. Proposed project will be subject to approval by the City Public Works Dept. Additional information is required. Provide discharge flow rates, quantities, frequency schedule, environmental analysis, water quality monitoring, NPDES, and any other necessary documentation for further review by Public Works and City Engineering Depts.

2. Refer to further conditions required by the Planning Dept.

3. A building permit is required. Standard plan check and inspection fees apply.

4. Proposed connection to existing storm drain main shall comply with current City standards. A 48" standard manhole is required for SD tie-in into existing City SD trunk line.

SUMMARY OF APPLICABLE DEVELOPMENT IMPACT FEES

Site Plan No: **17-103**
Date: **5/31/2017**

Summary of applicable Development Impact Fees to be collected at the time of building permit:
(Preliminary estimate only! Final fees will be based on the development fee schedule in effect at the time of building permit issuance.)

(Fee Schedule Date:**10/1/2016**)
(Project type for fee rates:**SITE IMPROVEMENT**)

Existing uses may qualify for credits on Development Impact Fees.

<u>FEE ITEM</u>	<u>FEE RATE</u>
<input type="checkbox"/> Groundwater Overdraft Mitigation Fee	
<input type="checkbox"/> Transportation Impact Fee	
<input type="checkbox"/> Trunk Line Capacity Fee	
<input type="checkbox"/> Sewer Front Foot Fee	
<input type="checkbox"/> Storm Drain Acq/Dev Fee	
<input type="checkbox"/> Park Acq/Dev Fee	
<input type="checkbox"/> Northeast Specific Plan Fees	
<input type="checkbox"/> Waterways Acquisition Fee	
<input type="checkbox"/> Public Safety Impact Fee: Police	
<input type="checkbox"/> Public Safety Impact Fee: Fire	
<input type="checkbox"/> Public Facility Impact Fee	
<input type="checkbox"/> Parking In-Lieu	

Reimbursement:

- 1.) No reimbursement shall be made except as provided in a written reimbursement agreement between the City and the developer entered into prior to commencement of construction of the subject facilities.
- 2.) Reimbursement is available for the development of arterial/collector streets as shown in the City's Circulation Element and funded in the City's transportation impact fee program. The developer will be reimbursed for construction costs and right of way dedications as outlined in Municipal Code Section 16.44. Reimbursement unit costs will be subject to those unit costs utilized as the basis for the transportation impact fee.
- 3.) Reimbursement is available for the construction of storm drain trunk lines and sanitary sewer trunk lines shown in the City's Storm Water Master Plan and Sanitary Sewer System Master Plan. The developer will be reimbursed for construction costs associated with the installation of these trunk lines.



Adrian Rubalcaba

SITE PLAN REVIEW COMMENTS

CITY OF VISALIA TRAFFIC SAFETY DIVISION

May 31, 2017

ITEM NO: 6
SITE PLAN NO: SPR17103
PROJECT TITLE: CALIFORNIA WATER SERVICE
DESCRIPTION: ADDITION OF GRANULAR ACTIVATED CARBON WELLHEAD WATER TREATMENT EQUIPMENT AT EXISTING WELL SITES. (R-1-5) (X)
APPLICANT: CALIFORNIA WATER SERVICE
PROP. OWNER: CALIF WATER SERVICE CO
APN: 095-232-009
LOCATION: 1622 S DEMAREE ST VISA

THE TRAFFIC DIVISION WILL PROHIBIT ON-STREET PARKING AS DEEMED NECESSARY

- No Comments
- See Previous Site Plan Comments
- Install Street Light(s) per City Standards.
- Install Street Name Blades at Locations.
- Install Stop Signs at Locations.
- Construct parking per City Standards PK-1 through PK-4.
- Construct drive approach per City Standards.
- Traffic Impact Analysis required.
 - Provide more traffic information such as . Depending on development size, characteristics, etc., a TIA may be required.

Additional Comments:

•



Leslie Blair

SITE PLAN REVIEW COMMENTS

Paul Bernal, Planning Division (559) 713-4025

Date: May 31, 2017

SITE PLAN NO: 2017-102
PROJECT: CALIFORNIA WATER SERVICE
DESCRIPTION: ADDITION OF GRANULAR ACTIVATED CARBON WELLHEAD WATER TREATMENT EQUIPMENT AT EXISTING WELL SITES. (R-1-5) (AE)
APPLICANT: CALIFORNIA WATER SERVICE
PROP. OWNER: CALIFORNIA WATER SERVICE CO
LOCATION TITLE: 711 W CAMBRIDGE AVE
APN TITLE: 096-341-008
GENERAL PLAN: Residential Low Density
ZONING: R-1-5 – Single-Family Residential 5,000 sq. ft. min. site area

Planning Division Recommendation:

- Revise and Proceed
 Resubmit

Project Requirements

- Variance for height of structure in rear yard setback
- Elevations
- Building Permit
- Additional Information as Needed

PROJECT SPECIFIC INFORMATION: 05/31/2017

1. A Variance is required for the Treatment Vessel and Fluidizing Water Holding Tank structures, which are proposed to be located in the required 25-foot rear yard area for the R-1-5 lot.
2. The Treatment Vessel and Fluidizing Water Holding Tank structures are considered an accessory structure and shall not exceed 12-feet in height in the required 25-foot rear yard area.
3. Provide elevations of the Treatment Vessels and Fluidizing Water Holding Tank structures with the Variance application submittal.
4. Provide responses to the five (5) Variance findings found attached to the Variance application.

CITY GENERAL PLAN CONSISTENCY

- Because this project requires discretionary approval by the City Council and/or Planning Commission the final determination of consistency will be made by the Planning Commission and/or City Council.

R-1-5 Single Family Residential Zone [17.12]

Maximum Building Height: 35 Feet

Minimum Setbacks:

	Building	Landscaping
➤ Front	15 Feet	15 Feet
➤ Front Garage (garage w/door to street)	22 Feet	22 Feet
➤ Side	5 Feet	5 Feet
➤ Street side on corner lot	10 Feet	10 Feet
➤ Rear	25 Feet*	25 Feet

Minimum Site Area: 5,000 square feet

Accessory Structures:

Maximum Height: 12 feet (as measured from average grade next to the structure)
Maximum Coverage: 20% of required Rear Yard (last 25 feet by the width)
Reverse Corner Lots: No structure in the 25 feet of adjacent lot's front yard area, see Zoning Ordinance Section 17.12.100 for complete standards and requirements.

Landscaping:

1. The City has adopted the State Water Efficient Landscape Ordinance. The ordinance applies to projects installing 2,500 square feet or more of landscaping. It requires that landscaping and irrigation plans be certified by a qualified entity (i.e., Landscape Architect) as meeting the State water conservation requirements. The City's implementation of this new State law will be accomplished by self-certification of the final landscape and irrigation plans by a California licensed landscape architect or other qualified entity with sections signed by appropriately licensed or certified persons as required by the ordinance. **NOTE: Prior to a final for the project, a signed Certificate of Compliance for the MWELO standards is required indicating that the landscaping has been installed to MWELO standards.**

NOTE: Staff recommendations contained in this document are not to be considered support for a particular action or project unless otherwise stated in the comments. The comments found on this document pertain to the site plan submitted for review on the above referenced date. Any changes made to the plan submitted must be submitted for additional review.

Signature  _____

City of Visalia
Building: Site Plan
Review Comments

ITEM NO: 8 D, May 31, 2017
SITE PLAN NO: SPR17103
PROJECT TITLE: CALIFORNIA WATER SERVICE
DESCRIPTION: ADDITION OF GRANULAR ACTIVATED CARBON WELLHEAD WATER TREATMENT EQUIPMENT AT EXISTING WELL SITES. (R-1-5) (X)
APPLICANT: CALIFORNIA WATER SERVICE
PROP OWNER: CALIF WATER SERVICE CO
LOCATION: 1622 S DEMAREE ST
APN(S): 095-232-009

NOTE: These are general comments and DO NOT constitute a complete plan check for your specific project
Please refer to the applicable California Codes & local ordinance for additional requirements.

- Business Tax Certification is required. *For information call (559) 713-4326*
- A building permit will be required. *For information call (559) 713-4444*
- Submit 4 sets of professionally prepared plans and 2 sets of calculations. (Small Tenant improvements)
- Submit 4 sets of plans prepared by an architect or engineer. Must comply with 2013 California Building Cod Sec. 2308 for conventional light-frame construction or submit 2 sets of engineered calculations.
- Indicate abandoned wells, septic systems and excavations on construction plans.
- You are responsible to ensure compliance with the following checked items:**

 Meet State and Federal requirements for accessibility for persons with disabilities.
- A path of travel, parking, common area and public right of way must comply with requirements for access for persons with disabilities.
- Multi family units shall be accessible or adaptable for persons with disabilities.
- Maintain sound transmission control between units minimum of 50 STC.
- Maintain fire-resistive requirements at property lines.
- A demolition permit & deposit is required. *For information call (559) 713-4444*
- Obtain required clearance from San Joaquin Valley Air Pollution Board. Prior to am demolition work
For information call (661) 392-5500
- Location of cashier must provide clear view of gas pump island
- Plans must be approved by the Tulare County Health Department. *For information call (559) 624-7400*
- Project is located in flood zone _____ * Hazardous materials report.
- Arrange for an on-site inspection. (Fee for inspection \$157.00) *For information call (559) 713-4444*
- School Development fees. Commercial \$0.56 per square foot. Residential \$3.75 per square foot.
- Existing address must be changed to be consistent with city address. *For information call (559) 713-4320*
- Acceptable as submitted
- No comments
- See previous comments dated: _____

Special comments: _____

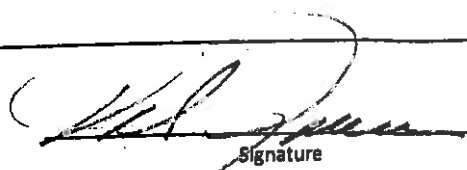
Signature Date: 5/31/17

SOLID WASTE DIVISION
336 N. BEN MADDOX
VISALIA CA. 93291
713 - 4500

17-098 - 17107
Cal Water well upgrades

COMMERCIAL BIN SERVICE

No Comments

Same comments as

Revisions required prior to submitting final plans. See comments below.

Resubmittal required. See comments below.

Customer responsible for all cardboard and other bulky recyclables to be broken down
be fore disposing of in recycle containers.

ALL refuse enclosures must be R-3 OR R-4

Customer must provide combination or keys for access to locked gates/bins

Type of refuse service not indica 16-06

Location of bin enclosure not acceptable. See comments below.

Bin enclosure not to city standards double.

Inadequate number of bins to provide sufficient service. See comments below.

Drive approach too narrow for refuse trucks access. See comments below.

Area not adequate for allowing refuse truck turning radius of :
Commercial (X) 50 ft. outside 36 ft. inside; Residential () 35 ft. outside, 20 ft. inside.

Paved areas should be engineered to withstand a 55,000 lb. refuse truck.

Bin enclosure gates are required

Hammerhead turnaround must be built per city standards.

Cul - de - sac must be built per city standards.

Bin enclosures are for city refuse containers only. Grease drums or any other
items are not allowed to be stored inside bin enclosures.

Area in front of refuse enclosure must be marked off indicating no parking

Enclosure will have to be designed and located for a STAB service (DIRECT ACCESS)
with no less than 38' clear space in front of the bin, included the front concrete pad.

Customer will be required to roll container out to curb for service.

Must be a concrete slab in front of enclosure as per city standards
The width of the enclosure by ten(10) feet, minimum of six(6) inches in depth.

Roll off compactor's must have a clearance of 3 feet from any wall or both sides and there must be a minimum of 53 feet clearance in front of the compactor to allow the truck enough room to provide service.

COMMENTS

Javier Hernandez, Solid Waste Front Load Supervisor 713-4338
Earl Nielsen, Solid Waste Manager

QUALITY ASSURANCE DIVISION
SITE PLAN REVIEW COMMENTS

ITEM NO: 6 DATE: May 31, 2017
SITE PLAN NO: SPR17103
PROJECT TITLE: CALIFORNIA WATER SERVICE
DESCRIPTION: ADDITION OF GRANULAR ACTIVATED CARBON
 WELLHEAD WATER TREATMENT EQUIPMENT AT
 EXISTING WELL SITES. (R-1-5) (X)
APPLICANT: CALIFORNIA WATER SERVICE
PROP OWNER: CALIF WATER SERVICE CO
LOCATION: 1622 S DEMAREE ST
APN(S): 095-232-009

YOU ARE REQUIRED TO COMPLY WITH THE CITY OF VISALIA WASTEWATER ORDINANCE 13.08 RELATIVE TO CONNECTION TO THE SEWER, PAYMENT OF CONNECTION FEES AND MONTHLY SEWER USER CHARGES. THE ORDINANCE ALSO RESTRICTS THE DISCHARGE OF CERTAIN NON-DOMESTIC WASTES INTO THE SANITARY SEWER SYSTEM.

YOUR PROJECT IS ALSO SUBJECT TO THE FOLLOWING REQUIREMENTS:

- WASTEWATER DISCHARGE PERMIT APPLICATION
- SAND AND GREASE INTERCEPTOR – 3 COMPARTMENT _____
- GREASE INTERCEPTOR min. 1000 GAL
- GARBAGE GRINDER – ¾ HP. MAXIMUM _____
- SUBMISSION OF A DRY PROCESS DECLARATION _____
- NO SINGLE PASS COOLING WATER IS PERMITTED _____
- OTHER _____
- SITE PLAN REVIEWED – NO COMMENTS

CALL THE QUALITY ASSURANCE DIVISION AT (559) 713-4529 IF YOU HAVE ANY QUESTIONS.

CITY OF VISALIA
PUBLIC WORKS DEPARTMENT
QUALITY ASSURANCE DIVISION
7579 AVENUE 288
VISALIA, CA 93277



AUTHORIZED SIGNATURE

5-26-17

DATE

City of Visalia
Parks and Urban Forestry
336 N. Ben Maddox Way
Visalia, CA 93292

Date: 5-30-17

Site Plan Review # 17163

SITE PLAN REVIEW COMMENTS

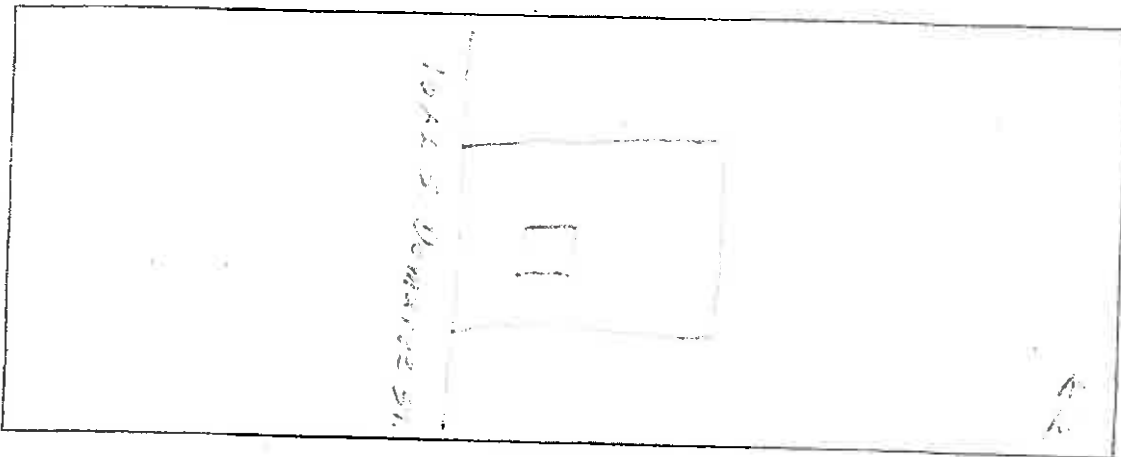

COMMENTS: See Below None

- Please plot and protect all Valley Oak Trees.
- Landscape along parkway to be planted by developer and maintained by a maintenance district.
- All drainage from curb and gutter along streets to be connected to storm drain system.
- All trees planted in street right-of-way to be approved by the Public Works Superintendent of Parks.
- Tie-ins to existing infrastructure may require a bore. Check with the Public Works Department prior to any street cut.

Other Comments: _____

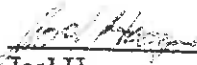
Joel Hooyer
Parks and Urban Forestry Supervisor
559 713-4295 Fax 559 713-4818

Email: jhooyer@ci.visalia.ca.us

ITEM NO: 2 DATE: May 31, 2017
SITE PLAN NO: SPR17099
PROJECT TITLE: CALIFORNIA WATER SERVICE
DESCRIPTION: ADDITION OF GRANULAR ACTIVATED CARBON WELLHEAD WATER TREATMENT EQUIPMENT AT EXISTING WELL SITES. (R-1-5) (X)
APPLICANT: CALIFORNIA WATER SERVICE
PROP OWNER: CALIF WATER SERVICE CO
LOCATION: 1718 W TULARE AVE
APN(S): 096-013-019

ITEM NO: 7 DATE: May 31, 2017
SITE PLAN NO: SPR17104
PROJECT TITLE: CALIFORNIA WATER SERVICE
DESCRIPTION: ADDITION OF GRANULAR ACTIVATED CARBON WELLHEAD WATER TREATMENT EQUIPMENT AT EXISTING WELL SITES. (R-1-5) (X)
APPLICANT: CALIFORNIA WATER SERVICE
PROP OWNER: CALIF WATER SERVICE CO
LOCATION: 621 W CALDWELL AVE
APN(S): 126-570-001

ITEM NO: 3 DATE: May 31, 2017
SITE PLAN NO: SPR17100
PROJECT TITLE: CALIFORNIA WATER SERVICE
DESCRIPTION: ADDITION OF GRANULAR ACTIVATED CARBON WELLHEAD WATER TREATMENT EQUIPMENT AT EXISTING WELL SITES. (R-M-2) (X)
APPLICANT: CALIFORNIA WATER SERVICE
PROP OWNER: CALIF WATER SERVICE CO
LOCATION: 2232 S SANTA FE ST
APN(S): 123-080-001

ITEM NO: 8 DATE: May 31, 2017
SITE PLAN NO: SPR17105
PROJECT TITLE: CALIFORNIA WATER SERVICE
DESCRIPTION: ADDITION OF GRANULAR ACTIVATED CARBON WELLHEAD WATER TREATMENT EQUIPMENT AT EXISTING WELL SITES. (R-1-5) (X)
APPLICANT: CALIFORNIA WATER SERVICE
PROP OWNER: CALIF WATER SERVICE CO (TR)
LOCATION: 2646 N MOONEY BLVD
APN(S): 090-222-001

ITEM NO: 4 DATE: May 31, 2017
SITE PLAN NO: SPR17101
PROJECT TITLE: CALIFORNIA WATER SERVICE
DESCRIPTION: ADDITION OF GRANULAR ACTIVATED CARBON WELLHEAD WATER TREATMENT EQUIPMENT AT EXISTING WELL SITES. (R-1-5) (X)
APPLICANT: CALIFORNIA WATER SERVICE
PROP OWNER: CALIF WATER SERVICE CO
LOCATION: 1920 W ASHLAND AVE
APN(S): 122-021-002

ITEM NO: 9 DATE: May 31, 2017
SITE PLAN NO: SPR17106
PROJECT TITLE: CALIFORNIA WATER SERVICE
DESCRIPTION: ADDITION OF GRANULAR ACTIVATED CARBON WELLHEAD WATER TREATMENT EQUIPMENT AT EXISTING WELL SITES. (R-1-5) (X)
APPLICANT: CALIFORNIA WATER SERVICE
PROP OWNER: CALIFORNIA WATER SERVICE COMPANY
LOCATION: 1303 S GARDEN ST
APN(S): 097-251-024

ITEM NO: 5 DATE: May 31, 2017
SITE PLAN NO: SPR17102
PROJECT TITLE: CALIFORNIA WATER SERVICE
DESCRIPTION: ADDITION OF GRANULAR ACTIVATED CARBON WELLHEAD WATER TREATMENT EQUIPMENT AT EXISTING WELL SITES. (R-1-5) (X)
APPLICANT: CALIFORNIA WATER SERVICE
PROP OWNER: CALIF WATER SERVICE CO
LOCATION: 711 W CAMBRIDGE AVE
APN(S): 096-341-008

ITEM NO: 10 DATE: May 31, 2017
SITE PLAN NO: SPR17107
PROJECT TITLE: CALIFORNIA WATER SERVICE
DESCRIPTION: ADDITION OF GRANULAR ACTIVATED CARBON WELLHEAD WATER TREATMENT EQUIPMENT AT EXISTING WELL SITES. (R-1-5) (X)
APPLICANT: CALIFORNIA WATER SERVICE
PROP OWNER: CALIFORNIA WATER SERVICE CO
LOCATION: 1601 E MONTE VERDE AVE
APN(S): 126-590-001

ITEM NO: 6 DATE: May 31, 2017
SITE PLAN NO: SPR17103
PROJECT TITLE: CALIFORNIA WATER SERVICE
DESCRIPTION: ADDITION OF GRANULAR ACTIVATED CARBON WELLHEAD WATER TREATMENT EQUIPMENT AT EXISTING WELL SITES. (R-1-5) (X)
APPLICANT: CALIFORNIA WATER SERVICE
PROP OWNER: CALIF WATER SERVICE CO
LOCATION: 1622 S DEMAREE ST
APN(S): 095-232-009

Police
** No Comment at this time*



Site Plan Review Comments For:

Visalia Fire Department
Kurtis A. Brown, Fire Marshal
707 W Acequia
Visalia, CA 93291
559-713-4261 Office
559-713-4808 Fax

ITEM NO: 6

D. May 31, 2017

SITE PLAN NO:

SPR17103

PROJECT TITLE:

CALIFORNIA WATER SERVICE

DESCRIPTION:

ADDITION OF GRANULAR ACTIVATED CARBON
WELLHEAD WATER TREATMENT EQUIPMENT AT
EXISTING WELL SITES. (R-1-5) (X)

APPLICANT:

CALIFORNIA WATER SERVICE

PROP OWNER:

CALIF WATER SERVICE CO

LOCATION:

1622 S DEMAREE ST

APN(S):

095-232-009

The following comments are applicable when checked:

- The Site Plan Review comments are issued as general overview of your project. With further details, additional requirements will be enforced at the Plan Review stage. Please refer to the 2016 California Fire Code (CFC), 2016 California Building Codes (CBC) and City of Visalia Municipal Codes.
- All fire detection, alarm, and extinguishing systems in existing buildings shall be maintained in an operative condition at all times and shall be replaced or repaired where defective. If building has been vacant for a significant amount of time, the fire detection, alarm, and or extinguishing systems may need to be evaluated by a licensed professional. *2016 CFC 901.6*
- No fire protection items required for parcel map or lot line adjustment; however, any future projects will be subject to fire & life safety requirements including fire protection.
- Construction and demolition sites prior to and during construction shall comply with the following:
 - Water Supply for fire protection, either temporary or permanent, shall be made available as soon as combustible materials arrive on the site. *2016 CFC 3312*
 - An all-weather, 20 feet width Construction Access Road capable of holding a 75,000 pound fire apparatus. Fire apparatus access shall be provided within 100 feet of temporary or permanent fire department connections. *2016 CFC 3310*
- More information is needed before a Site Plan Review can be conducted. Please submit plans with more detail. Please include information on

General:

- Address numbers must be placed on the exterior of the building in such a position as to be clearly and plainly visible from the street. Numbers will be at least four inches (4") high and shall be of a color to contrast with their background. If multiple addresses served are by a common driveway, the range of numbers shall be posted at the roadway/driveway. *2016 CFC 505.1*
- All hardware on exit doors, illuminated exit signs and emergency lighting shall comply with the 2016 California Fire Code. This includes all locks, latches, bolt locks, panic hardware, fire exit hardware and gates.
- Commercial dumpsters with 1.5 cubic yards or more shall not be stored or placed within 5 feet of combustible walls, openings, or a combustible roof eave line except when protected by a fire sprinkler system. *2016 CFC 304.3.3*

- A Knox Box key lock system is required. Where access to or within a structure or area is restricted because of secured openings (doors and/or gates), a key box is to be installed in an approved location. The key box shall be ordered using an approved Knox Authorization Order Form. The forms are located at the fire department administration office located at 707 W. Acequia, Visalia, CA 93291. Please allow adequate time for shipping and installation. *2016 CFC 506.1*
- If your business handles hazardous material in amounts that exceed the Maximum Allowable Quantities listed on *Table 5003.1.1(1), 5003.1.1(2), 5003.1.1(3) and 5003.1.1(4) of the 2016 California Fire Code*, you are required to submit an emergency response plan to the Tulare County Health Department. Also you shall indicate the quantities on your building plans and prior to the building final inspection a copy of your emergency response plan and Safety Data Sheets shall be submitted to the Visalia Fire Department.

Water Supply for Residential, Commercial & Industrial:

Residential

- Fire hydrant spacing and location shall comply with the following requirements:
The exact location and number of fire hydrants shall be at the discretion of the fire marshal, fire chief and/or their designee. *Visalia Municipal Code 16.36.120(5)*
 - Single-family residential developments shall be provided with fire hydrants every six hundred (600) lineal feet of residential frontage. In isolated developments, no less than two (2) fire hydrants shall be provided.
 - Multi-family, zero lot line clearance, mobile home park or condominium developments shall be provided with fire hydrants every four hundred (400) lineal feet of frontage. In isolated developments, no less than two (2) fire hydrants shall be provided.
 - Multi-family or condominium developments with one hundred (100) percent coverage fire sprinkler systems shall be provided with fire hydrants every six (600) lineal feet of frontage. In isolated developments, no less than two (2) fire hydrants shall be provided.

Commercial & Industrial

- Where a portion of the facility or building is more than 400 feet from a hydrant on a fire apparatus access road, on-site fire hydrant(s) shall be provided. *2016 CFC 507.5.1*
- Due to insufficient building information, the number and distance between fire hydrants cannot be determined by the Site Plan Review process. The number of fire hydrants and distance between required fire hydrants shall be determined by utilizing type of construction and square footage in accordance with *CFC 2016 Appendix C102 & C103 & CFC 507.5.1*
- To determine fire hydrant location(s) and distribution the following information was provided to the Site Plan Review committee: **Type of construction** _____ **Square footage** _____

Emergency Access

- A fire apparatus access roads shall be provided and must comply with the 2016 CFC and extend within 150 of all portions of the facility and all portions of the exterior walls of the first story of the building as measured by an approved route around the exterior of the building or facility. Fire apparatus access

roads shall have an unobstructed width of not less than 20 feet. Minimum turning radius for emergency fire apparatus shall be 20 feet inside radius and 43 feet outside radius. *2016 CFC 503.1.1*

- Buildings or portions of buildings or facilities with a vertical distance between the grade plan and the highest roof surface that exceed 30 feet shall provide an approved fire apparatus access roads capable of accommodating fire department aerial apparatus.
 - Access roads shall have a minimum unobstructed width of 26 feet, exclusive of shoulders.
 - Access routes shall be located within a minimum of 15 feet and maximum of 30 feet from the building, and shall be positioned parallel to one entire side of the building.
 - Overhead utility and power lines shall not be located over the aerial fire apparatus access road or between the aerial fire apparatus road and the building.

- Fire apparatus access roads in excess of 150 feet and dead end shall be provided with a turnaround. Fire apparatus access roads with a length of 151-500 feet shall be a minimum of 20 feet in width. Length of 501-750 feet shall be 26 feet in width. *2016 CFC Table D103.4*

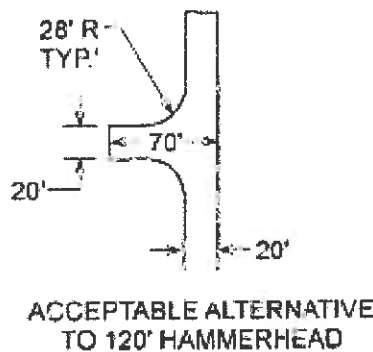
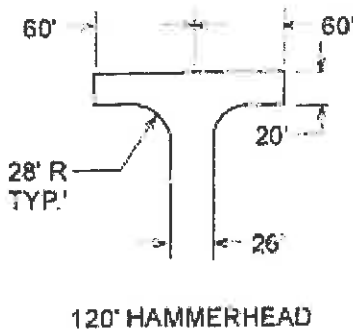
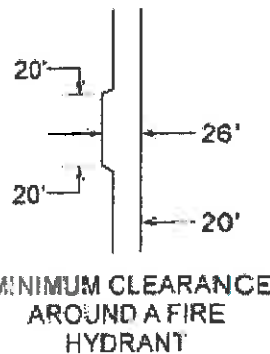
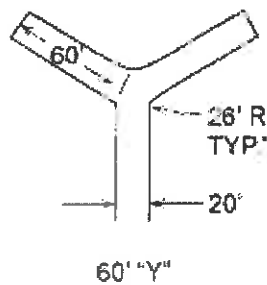
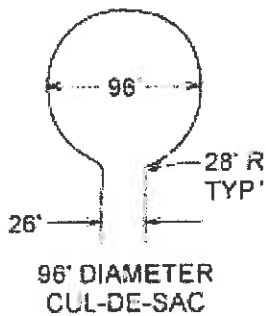

- Approved No PARKING – FIRE LANE signs shall be provided for fire apparatus access roads to identify such roads or prohibit the obstruction thereof. Signs shall have a minimum dimension of 12 inches wide by 18 inches high and have red letters on a white reflective background. *2013 CFC 503.3/D103.6*

SIGN TYPE "A"



SIGN TYPE "C"



SIGN TYPE "D"



18"

- On site Fire Apparatus Access Roads shall be provided and have an unobstructed width of not less than the following:
 - 20 feet width, exclusive of shoulders (No Parking)
 - More than 26 feet width, exclusive of shoulders (No Parking one side)
 - More than 32 feet wide, exclusive of shoulders (Parking permitted on both sides)

- Marking- approved signs, other approved notices or marking that include the words "NO PARKING-FIRE LANE shall be provided for fire apparatus access roads to identify such roads or prohibit the obstruction thereof. *CFC 503.3*

- Gates on access roads shall be a minimum width of 20 feet and shall comply with the following: *2016 CFC D103.5*
 - Gates shall be of the swinging or sliding type.
 - Gates shall allow manual operation by one person (power outages).
 - Gates shall be maintained in an operative condition at all times.
 - Electric gates shall be equipped with a means of opening the gate by fire department personnel for emergency access. (Note: Knox boxes shall be ordered using an approved Knox Authorization Order Form. The forms are located at the fire department administration office located at 707 W. Acequia, Visalia, CA 93291. Please allow adequate time for shipping and installation.)

- Streets shall meet the City of Visalia's Design & Improvement Standards for streets to ensure that fire apparatus can make access to all structures in the event of an emergency.

Fire Protection Systems

- An automatic fire sprinkler system will be required for this building. Also, a fire hydrant is required within 50 feet of the Fire Department Connection (FDC). Where an existing building is retrofitted with a sprinkler system (NFPA 13 or NFPA 13R) a fire hydrant shall be provided within 75 feet of the FDC. An additional 25 feet of distance between a fire hydrant and FDC may be granted when a fire sprinkler Density is designed with an additional 25%. *2016 CFC 912 and Visalia Municipal Code 8.20.010 subsection C103.4*

- Locking fire department connection (FDC) caps are required. The caps shall be ordered using an approved Knox Authorization Order Form. The forms are located at the fire department administration office located at 707 W. Acequia, Visalia, CA 93291. *2016 CFC 912.4.1*

- Commercial cooking appliances and domestic cooking appliances used for commercial purposes that produces grease laden vapors shall be provided with a Type 1 Hood, in accordance with the California Mechanical Code, and an automatic fire extinguishing system. *2016 CFC 904.12 & 609.2*

Special Comments:

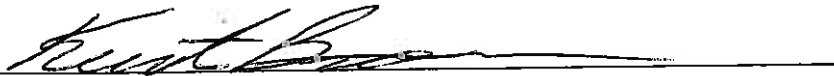
 Kurtis A. Brown
 Fire Marshal

City of Visalia



Land Use Designations



City of Visalia

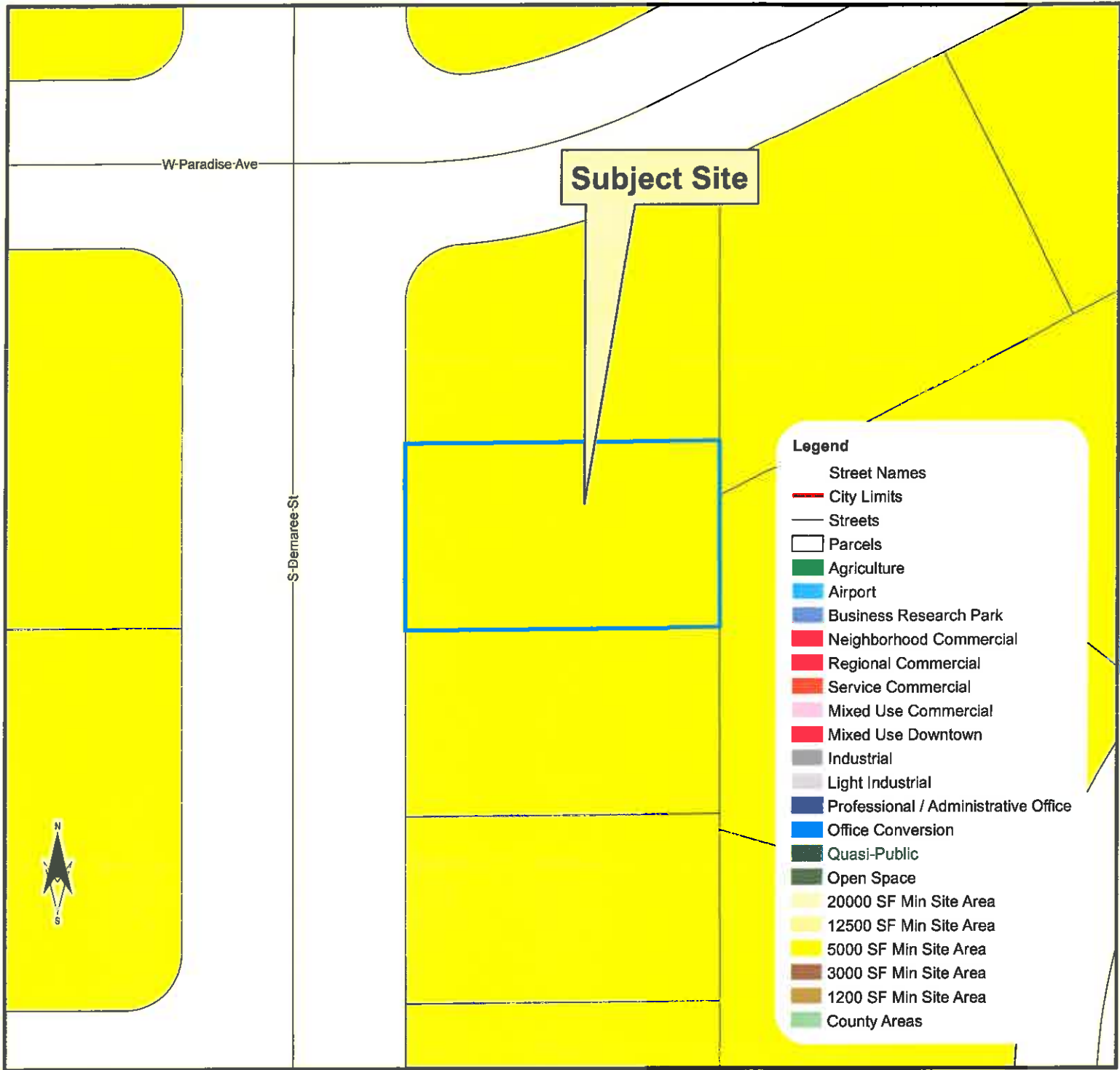

Zoning Designations



City of Visalia



Aerial Photo



City of Visalia



Location Map

